

SMD Power Inductor CDRH5D16

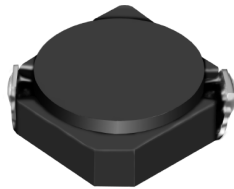

Halogen Free



Description

- Ferrite drum core construction.
- Magnetically shielded.
- L × W × H: 5.8 × 5.8 × 1.8 mm Max.
- Product weight: 1.88mg(Ref.)
- Moisture Sensitivity Level: 1
- RoHS compliance.
- Halogen Free available.

Environmental Data

- Operating temperature range: -40°C~+105°C (including coil's self temperature rise)
- Storage temperature range: -40°C~+105°C
- Solder reflow temperature: 260 °C peak.

Packaging

- Carrier tape and reel packaging
- 7.0" diameter reel
- 1000pcs per reel

Applications

- Ideally used in Mobile phone, Notebook PC, MP3, PDA, HDD, DSC/DVC, Game machine, etc. as DC-DC converter inductors.

Dimension - [mm]

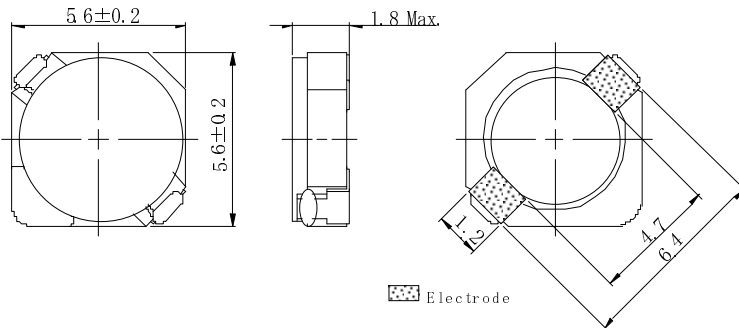

Land pattern and Schematics - [mm]

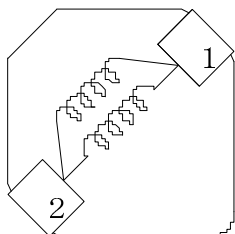
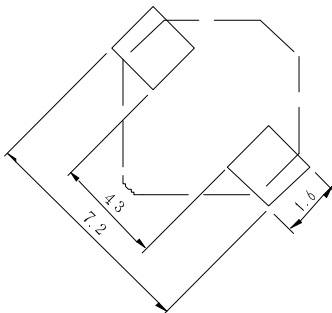

(0.90 μH ~ 10.0 μH)

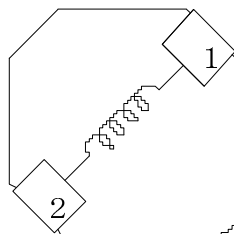

(15.0 μH ~ 100 μH)

SMD Power Inductor CDRH5D16



Electrical Characteristics

Part Name	Stamp	Inductance (μ H) [within] ※1	D.C.R.(Ω) [Max.] (Typ.) (at 20°C)	Saturation Current (A) ※2		Temperature Rise Current (A) ※3
				at 20°C	at 105°C	
CDRH5D16NP-0R9NC	0R9	0.90 \pm 25%	14.6m(11.7m)	4.70	3.90	4.70
CDRH5D16NP-2R2NC	2R2	2.2 \pm 25%	35.9m(28.7m)	3.00	2.45	2.90
CDRH5D16NP-3R3NC	3R3	3.3 \pm 25%	44.5m(35.6m)	2.60	2.15	2.40
CDRH5D16NP-4R7NC	4R7	4.7 \pm 25%	64.1m(51.3m)	2.15	1.75	2.10
CDRH5D16NP-6R8NC	6R8	6.8 \pm 25%	84.3m(67.4m)	1.80	1.45	1.70
CDRH5D16NP-8R2NC	8R2	8.2 \pm 25%	0.11(89.7m)	1.55	1.25	1.50
CDRH5D16NP-100MC	100	10.0 \pm 20%	0.14(0.11)	1.45	1.15	1.30
CDRH5D16NP-150MC	150	15.0 \pm 20%	0.20(0.16)	1.15	0.95	1.10
CDRH5D16NP-220MC	220	22.0 \pm 20%	0.32(0.25)	0.95	0.80	0.80
CDRH5D16NP-330MC	330	33.0 \pm 20%	0.44(0.35)	0.80	0.65	0.70
CDRH5D16NP-470MC	470	47.0 \pm 20%	0.58(0.46)	0.68	0.52	0.60
CDRH5D16NP-680MC	680	68.0 \pm 20%	0.86(0.69)	0.55	0.44	0.50
CDRH5D16NP-820MC	820	82.0 \pm 20%	1.06(0.85)	0.50	0.40	0.42
CDRH5D16NP-101MC	101	100 \pm 20%	1.41(1.13)	0.45	0.35	0.35

※1. Inductance measuring condition: at 100kHz.

※2. Saturation current: The value of D.C. current when the inductance decreases to 65% of it's nominal value.

※3. Temperature rise current: The value of D.C. current when the temperature rise is $\Delta t=40^{\circ}\text{C}$ ($T_a=20^{\circ}\text{C}$).

SMD Power Inductor CDRH5D16



Saturation Current & Temperature Rise Graph

— L (20°C) — L (105°C) — ΔT

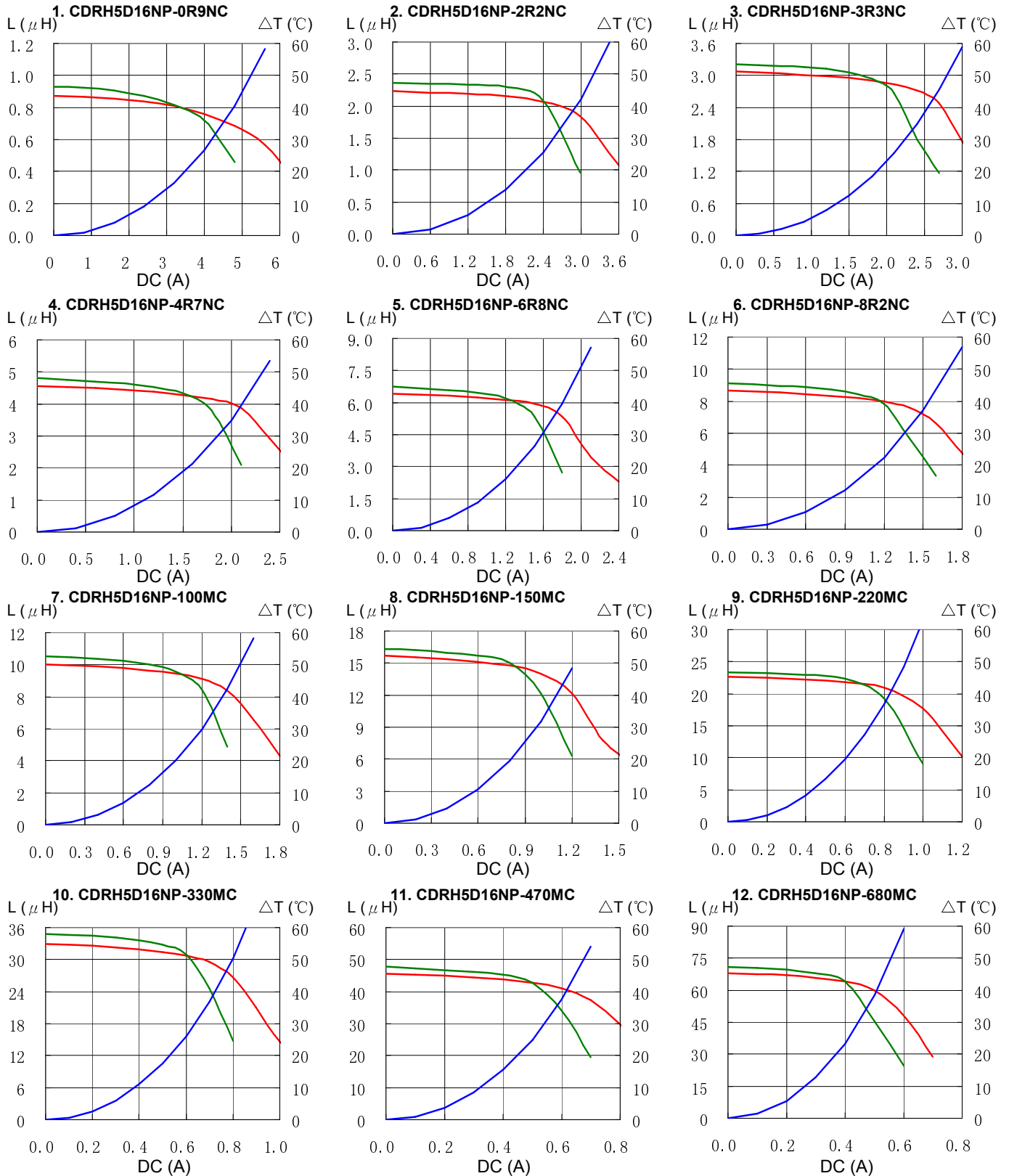

SMD Power Inductor CDRH5D16



Saturation Current & Temperature Rise Graph

— L (20°C) — L (105°C) — ΔT

13. CDRH5D16NP-820MC

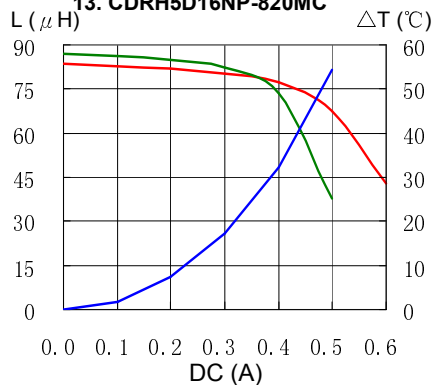

14. CDRH5D16NP-101MC

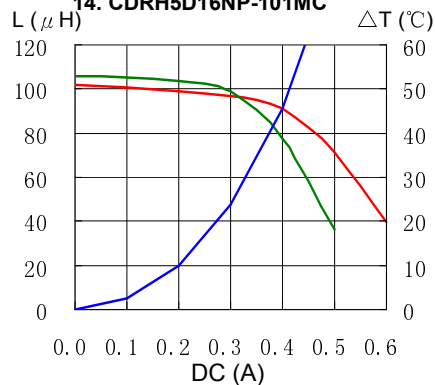

Solder Reflow Condition

Heat Endurance

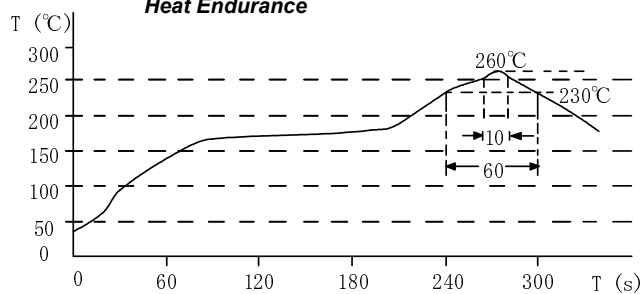

Temperature Chart

